

xGen™ Amplicon panels leverage super amplicon technology

Increase confidence across a variety of samples

Providing a solution for novel mutations

Targeted NGS sequencing is a useful tool for analyzing specific sequences in a sample and enabling deep sequencing. The short read limits of Illumina® sequencing result in multiple amplicons being required to span larger targets of interest, such as whole genes, large exons, or whole genomes. Many methods require separate PCR reactions to achieve continuous coverage, resulting in increased input material, time, cost, and the increased possibility of user errors and sample mixing compared to a single-tube method. A benefit of the xGen Amplicon technology is the formation of “super” amplicons formed during the single-tube workflow. Super amplicons provide coverage in situations where novel mutations negatively affect primer function. This feature allows for full sequencing of the region of interest, even in the case of unknown novel mutations. Sequencing of the rapidly evolving SARS-CoV-2 genome provides an excellent example of the value of full genomic coverage, no matter the mutations found in the sample.

The xGen Amplicon technology leverages a multiplex PCR reaction that generates libraries with overlapping amplicon coverage in a single tube. This results in additional minor species of larger amplicons that are not observed with multi-tube workflows. “Super” amplicons are created from distant forward and reverse primers in nearby or overlapping amplicons (F1 and R2 in [Figure 1](#)). “Mini” amplicons are caused by neighboring forward and reverse primers in overlapping amplicons (F2 and R1 in [Figure 1](#)).

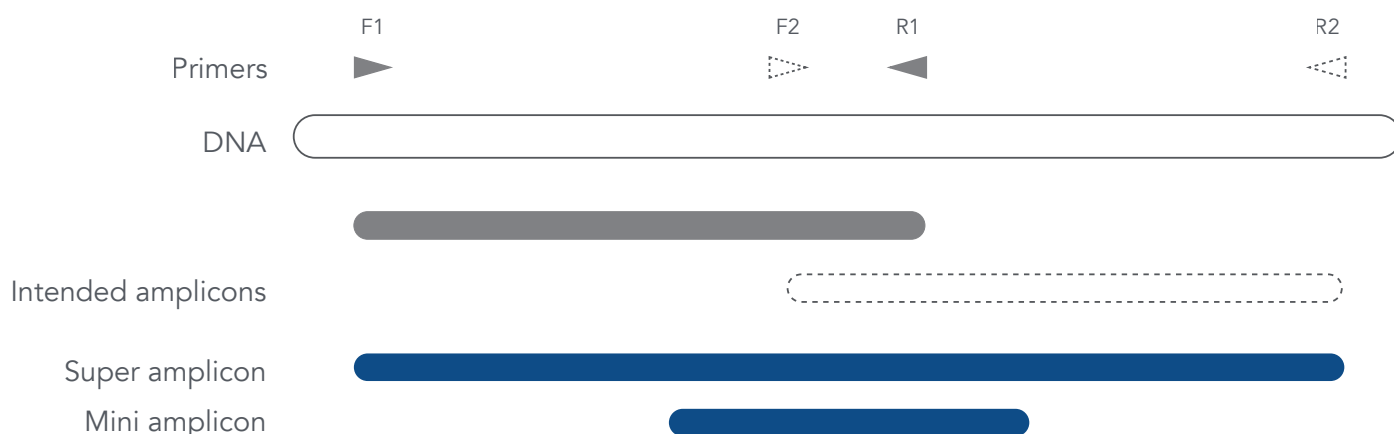

Figure 1. Creating super amplicons and mini amplicons. With two overlapping amplicons, the 4 primers involved can create 4 different amplicons: the two designed or intended amplicons, a super amplicon that spans both intended amplicons, and a mini amplicon. The super amplicon is created from F1 and R2 primers. The mini amplicon is created from F2 and R1 primers.

> SEE WHAT MORE WE CAN DO FOR YOU AT WWW.IDTDNA.COM.

In many multiplex PCR methods, having overlapping amplicons in a single tube would result in the mini amplicons being over-represented and the major species, resulting in lost data and over-clustered sequencing runs. IDT's multiplex PCR technology avoids the issues inherent with mini amplicons (Figure 2) while maintaining the super amplicons to provide coverage in the case of primer dropout.

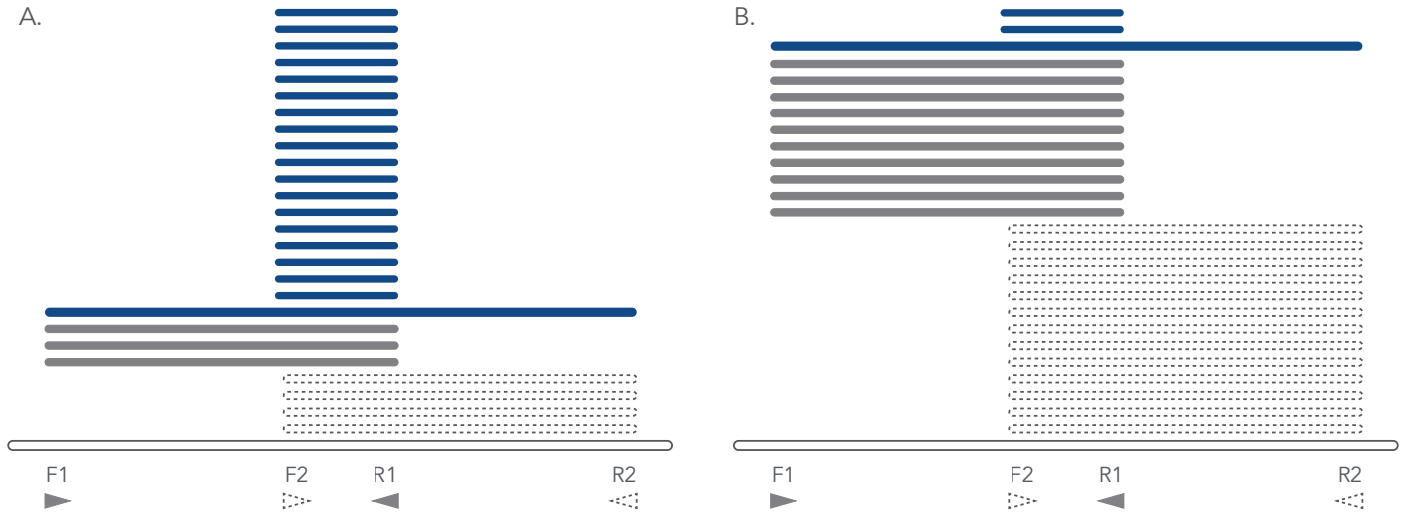

Figure 2. Importance of overlapping amplicon coverage. (A) Mini amplicons can easily be overrepresented in libraries and in data due to PCR more efficiently amplifying small fragments, mini amplicons having more available template positions, and small libraries seeding more efficiently on Illumina flow cells. Skewing towards overrepresentation of mini amplicons results in significant data loss. (B) When achieving single-tube, overlapping amplicon coverage, xGen Amplicon technology results in data consisting of mainly the intended and super amplicons.

Super amplicons span across two or more intended amplicons and provide additional insights that can increase both coverage and variant calling confidence. Super amplicons cannot form in two-tube workflows where the primers for overlapping amplicons are sequestered into separate tubes. Due to their size, super amplicons are mostly outnumbered by intended amplicons. They are also less likely to form in damaged or fragmented DNA, for example, FFPE or cfDNA.

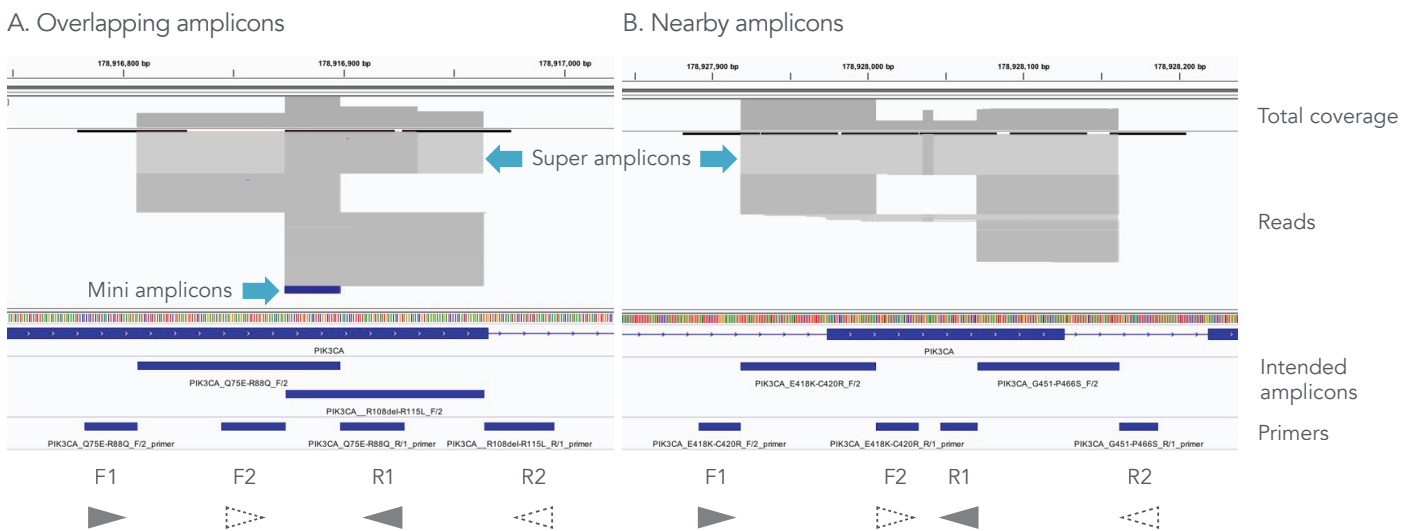

Figure 3. Single-tube amplicon coverage for PIK3CA in xGen Amplicon 56G panel. (A) In the case of overlapping amplicons, the super amplicon, intended amplicons, and mini amplicon (blue) can clearly be discerned. The mini amplicon is a minor fraction of the observed reads. (B) If the amplicons do not overlap but are located near each other, the super amplicon is created, but the mini amplicon is not. Visualized in IGV (Broad Institute). The library was generated from 10 ng of HD701 and sequenced on an Illumina MiniSeq.

xGen Amplicon's single-tube workflow is also beneficial for variant or mutation discovery. In the case of many amplicon technologies, the presence of a novel variant under a primer binding site would result in loss of coverage (grey in [Figure 4](#)). With any overlapping amplicon technology, the variant should be observable with the adjacent amplicon (blue in [Figure 4](#)). In the case of large deletions, this may not always be the case. But with a single-tube workflow that can produce super amplicons, the super amplicon provides coverage for the sequence covered by the amplicon with the disrupted primer binding site (purple in [Figure 4](#)), in addition to confirming the variant.

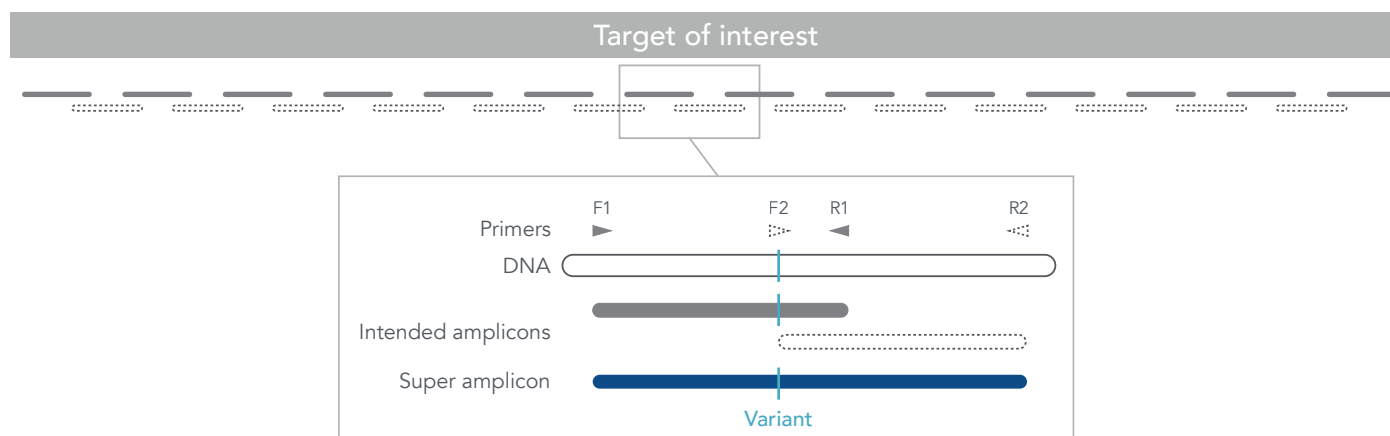

Figure 4. Advantages of using super amplicons. If a variant (*) occurs at a primer binding site, it is still observable in the data. If the F2 primer is no longer functional, the variant will still be seen in the intended (F1–R1) and super amplicon (F1–R2). Coverage between F2 and R2 will come from super amplicons and so may be impacted but will be present. Larger deletions spanning the F2 and R1 binding sites will also be observable from super amplicons, which is only possible with a single-tube multiplex PCR. The same situation occurs with all adjacent amplicons (not shown).

SARS-CoV-2 case study

Because of these advantages, xGen Amplicon's single-tube workflows provide a robust method to achieve continuous coverage across genomes that are continuously mutating. For example, the SARS-CoV-2 genome is 29.9 kb and the xGen Amplicon SARS-CoV-2 panel spans 99.7% (29,828 of 29,903 total bases) using 345 amplicons with continuous coverage across the genome ([Figure 5](#)). The super amplicons generated with xGen technology allow for sequencing of highly mutated regions without changing the primer pool. The xGen SARS-CoV-2 amplicon panel achieves full genomic coverage of all known SARS-CoV-2 strains, including the Omicron variant, with the same set of primers. The S gene of the Omicron variant has many mutations occurring in close proximity. Achieving full genomic coverage would be difficult for a traditional amplicon approach, but the xGen Amplicon panel maintains continuous coverage through this region ([Figure 5](#), BA.1). This robustness means that iterating and revalidation panel contents are not required for every new variant of SARS-CoV-2 or another target genome or unexpected mutation when using the xGen Amplicon technology ([Figure 5](#)).

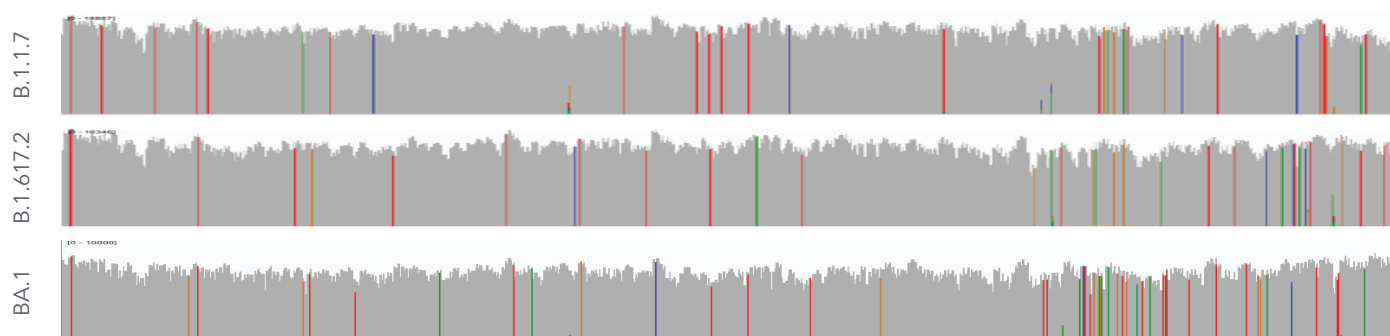

Figure 5. Complete coverage of the SARS-CoV-2 genome. Genomic coverage of the Alpha (B.1.1.7), Delta (B.1.617.2), and Omicron (BA.1) variants are shown. These data were generated with the same primer set (xGen Amplicon SARS-CoV-2 Full genome coverage) and all panels achieved full genomic coverage, demonstrating how the xGen Amplicon technology is able to perform consistently with a rapidly changing genome. Libraries were sequenced on an Illumina MiniSeq using 2 x 150 pair-end reads and subsampled to 280 K reads.

An excellent example of how overlapping amplicons in a single tube can help maintain coverage is provided by the SARS-CoV-2 variant B.1.1.7. This variant involves a deletion (SGF 3675–3677, del11288–11296) that occurs in the binding site of a primer in the xGen Amplicon SARS-CoV-2 panel (Figure 6A). Despite this mutation, which impacts the functionality of this primer, full coverage of the region is maintained (Figure 6B) due to the formation of sequencing accessible super amplicons.

A.



B.

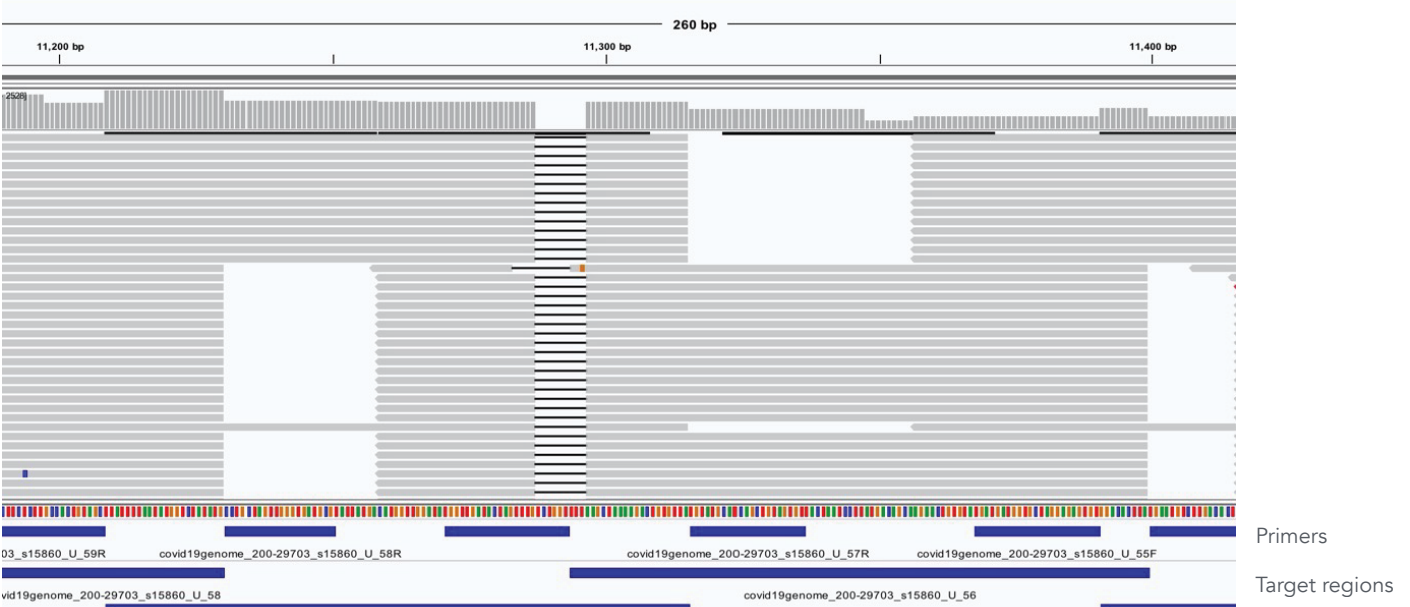

Figure 6. Coverage of the SGF 3675–3677 deletion. The xGen Amplicon SARS-CoV-2 panel was used to sequence UK variant (B.1.1.7) from a swab sample provided by Genemarkers LLC. Full genomic coverage was achieved. Visualized in IGV (Broad Institute). The library was sequenced on an Illumina MiniSeq.

In addition to SARS-CoV-2, panels for other infectious diseases have been developed. Monkeypox (MPX) had been termed a global health emergency and presents an interesting challenge for amplicon sequencing due to the size of its genome which is significantly larger than the SARS-CoV-2 genome (~200 kb and ~30 kb, respectively). The IDT xGen Amplicon Monkeypox Panel provides comprehensive coverage over >184 kb of the Monkeypox genome (positions 6760-190,905, ITRs not included) using 1892 amplicons in a single-tube workflow. ITR coverage was incorporated at a later date and is included in the genomic coverage shown in Figure 7. The MPX genomic coverage shown in Figure 7 demonstrates that xGen Amplicon panels are not limited to SARS-CoV-2 and can be used more widely to assess pathogenic genomes and other larger targets.

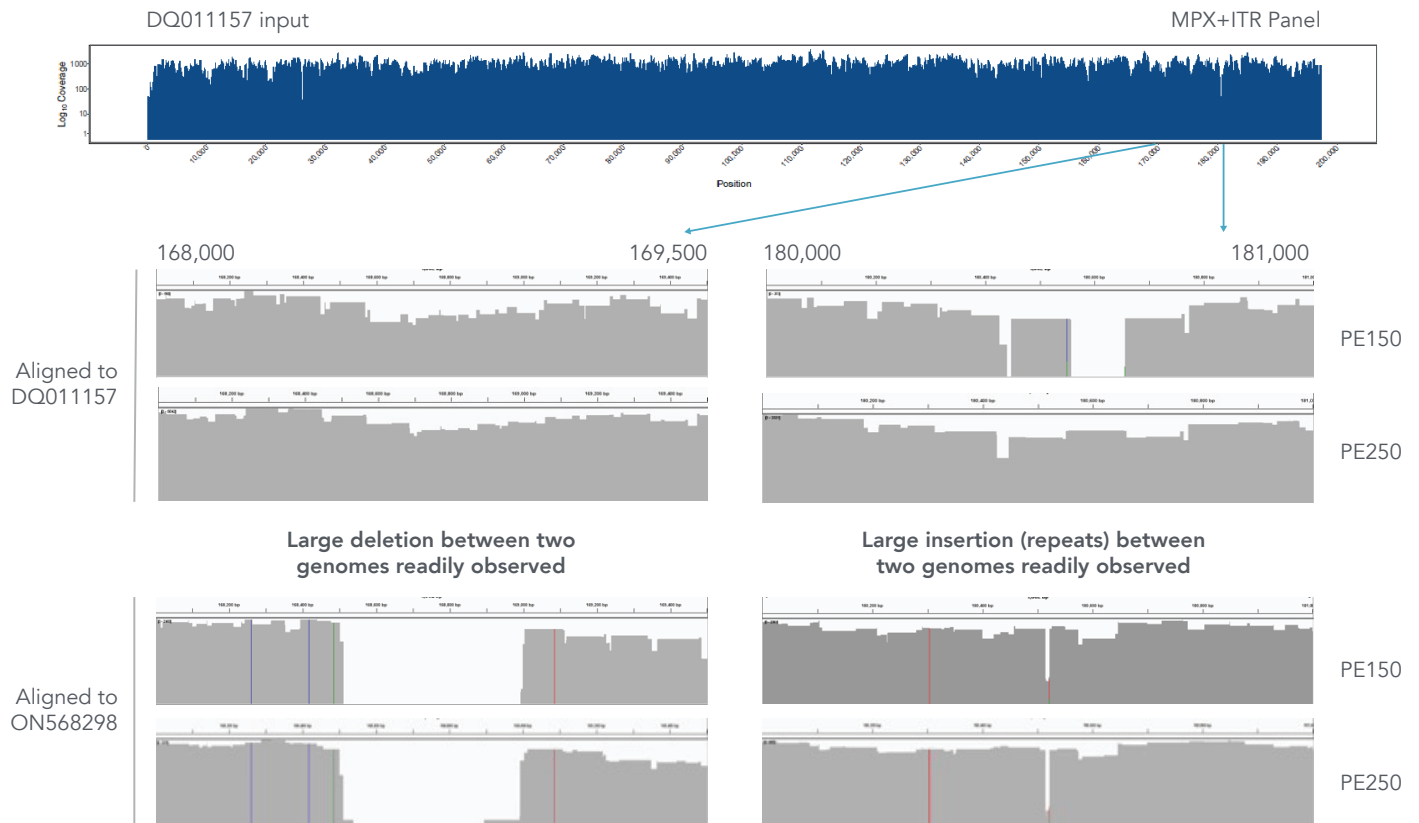

Figure 7. The genomic coverage of the Monkeypox genome generated by the xGen Amplicon Monkeypox panel. Three thousand copies of the Monkey pox genome (BEI Resources, NR-4928) and 10 ng of Coriell DNA NA12878 (human) were used as input material into the xGen Amplicon Monkeypox workflow. The full coverage data were generated using the MPX panel with the additional ITR coverage (CP-618). The resulting NGS library was sequenced on a MiSeq (Illumina) with 250 bp paired-end sequencing and a MiniSeq (Illumina) with 150 bp paired-end sequencing. The resulting reads were then aligned to either the input genome (DQ011157) or the Monkeypox genome that the primers were designed for (ON568298). Large insertions and deletions between the two genomes were easily observed.

Conclusion

The xGen Amplicon technology brings many benefits, including a single-tube workflow and robust coverage, and is not limited to a discrete number of amplicons in an overlapping amplicon set, like other amplicon technologies. Super amplicons provide the data necessary for maintaining genomic coverage, in highly mutated samples, larger deletions and insertions, or in the presence of novel mutations.

xGen Amplicon panels leverage super amplicon technology

For more information, go to: www.idtdna.com/ContactUs

For more than 30 years, IDT's innovative tools and solutions for genomics applications have been driving advances that inspire scientists to dream big and achieve their next breakthroughs. IDT develops, manufactures, and markets nucleic acid products that support the life sciences industry in the areas of academic and commercial research, agriculture, medical diagnostics, and pharmaceutical development. We have a global reach with personalized customer service.

> SEE WHAT MORE WE CAN DO FOR YOU AT WWW.IDTDNA.COM.

For Research Use Only. Not for diagnostic procedures. Unless otherwise agreed to in writing, IDT does not intend these products to be used in clinical applications and does not warrant their fitness or suitability for any clinical diagnostic use. Purchaser is solely responsible for all decisions regarding the use of these products and any associated regulatory or legal obligations.

© 2023 Integrated DNA Technologies, Inc. All rights reserved. Trademarks contained herein are the property of Integrated DNA Technologies, Inc. or their respective owners. For specific trademark and licensing information, see www.idtdna.com/trademarks.
Doc ID: RUO23-2304_001 09/23